



# Building Guide

Colorado Chapter of the International Code Council

## Single Family Residential One Story Detached Garage

### How to Use this Guide

Provide two sets of plans, drawn to scale and complete the following (*hint: use graph paper with 1/4" squares. Example: 1/4" = 1'*): Check with your jurisdiction for additional requirements.

**1 Complete this Building Guide** by filling in the blanks on page two and four, and indicating which construction details will be used.

**2 Provide Plot Plan** (site plan) showing dimensions of your project and its relationship to existing buildings or structures on the property and the distance to existing property lines, drawn to scale. See page 3.

**3 Fill out a building permit application.**

The majority of permit applications are processed with little delay. The submitted documents will help determine if the project is in compliance with building safety codes, zoning ordinances and other applicable laws.

The Colorado Chapter of the International Code Council is a professional organization seeking to promote the public health, safety and welfare to building construction. We appreciate your feedback and suggestions. To obtain a master copy of this building guide, please write to the Colorado Chapter of the International Code Council, P.O. Box 961, Arvada, CO 80001.  
<http://www.coloradochaptericc.org>

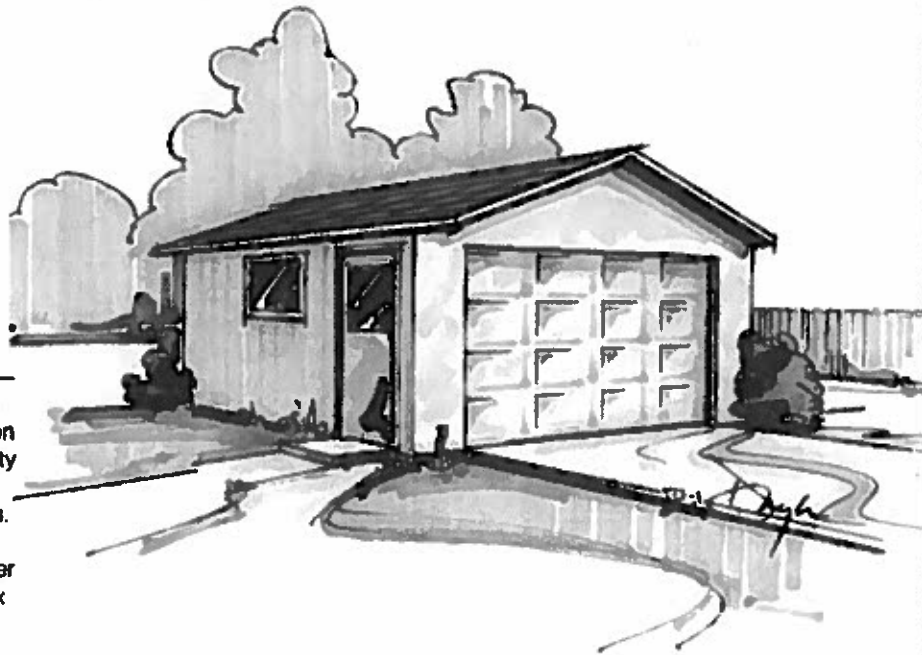

This handout was developed by the Colorado Chapter of the International Code Council as a basic plan submittal under the 2012 International Residential Code. It is not intended to cover all circumstances. Check with your Department of Building Safety for additional requirements.

# Single Family Residential One Story Detached Garage

## Directions

1. Fill in the blanks on pages 2 and 4 with dimensions and materials which will be used to build the structure. Please print legibly.

2. Indicate in the check boxes on page 4 which details from page 5 will be used.

Note: Heated garages will require insulation, such as ceilings, walls, and foundation.

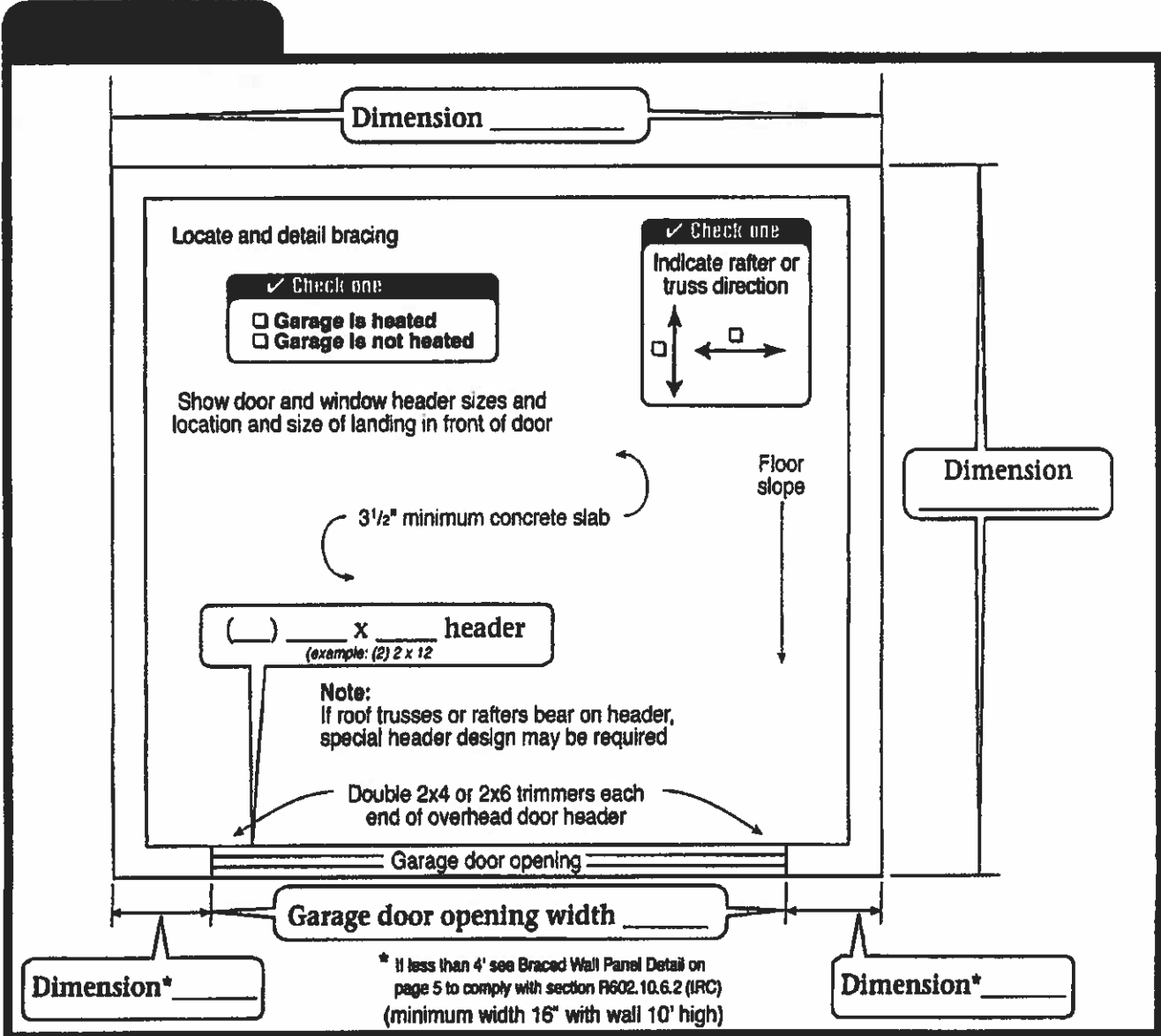

This handout was developed by the Colorado Chapter of the International Code Council as a basic plan submittal under the 2012 International Residential Code. It is not intended to cover all circumstances. Check with your Department of Building Safety for additional requirements.

# Single Family Residential One Story Detached Garage

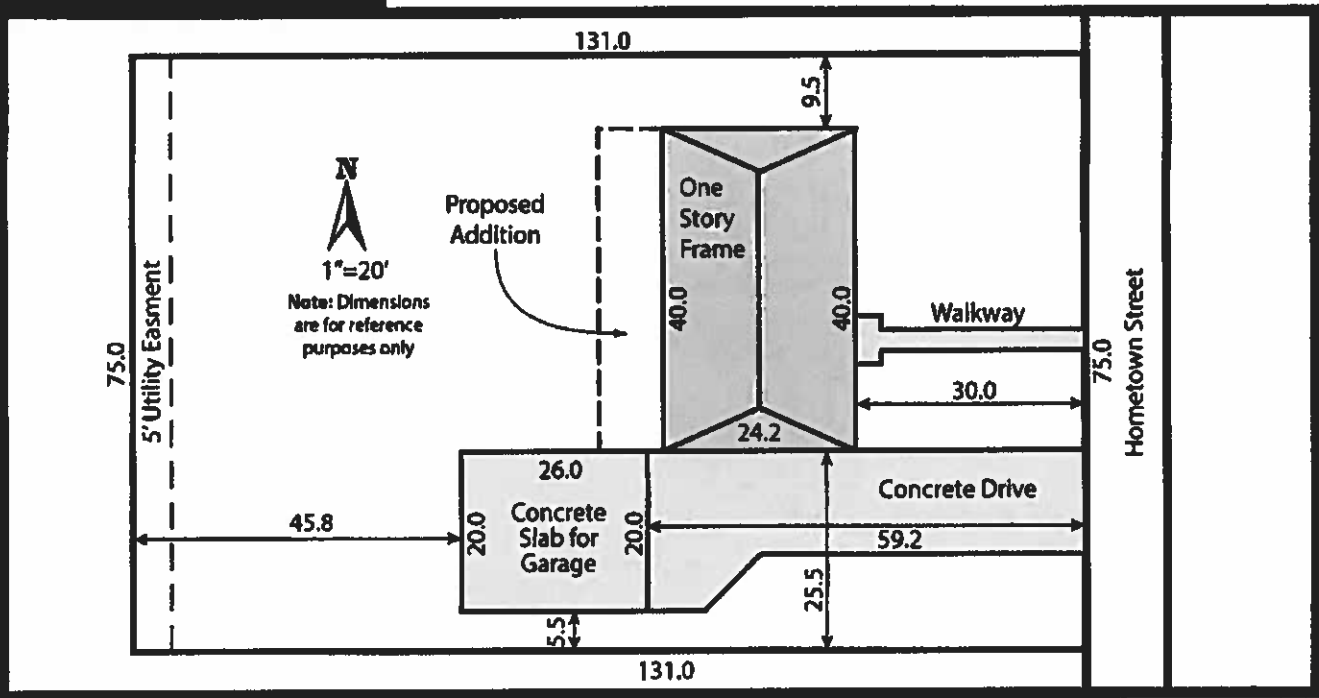

This handout was developed by the Colorado Chapter of the International Code Council as a basic plan submittal under the 2012 International Residential Code. It is not intended to cover all circumstances. Check with your Department of Building Safety for additional requirements.



# Single Family Residential One Story Detached Garage

Note: For roofs with slopes less than 4:12, follow manufacturer's instructions for low slope application of roofing material.

Truss or 2x \_\_\_\_\_ rafters spaced \_\_\_\_\_" O.C.  
(example: Put checkmark in box -or- 2 x 10 Rafters Spaced 24")

Sheathing \_\_\_\_\_  
(example: 1/2" exterior plywood)

Minimum 1x \_\_\_\_\_ ridge board  
(example: 1 x 12)

Roof covering \_\_\_\_\_  
(example: Class A 3 tab shingles)

Underlayment \_\_\_\_\_  
(example: 1 layer #15 felt)

12  
pitch | \_\_\_\_\_

Ceiling Insulation \_\_\_\_\_  
(If heated - example: R-38)

2x \_\_\_\_\_ ceiling joists @ \_\_\_\_\_ O.C.  
(example: 2 x 8 @ 24" O.C.)

Double 2x \_\_\_\_\_ top plate  
(example: 2 x 6)

Span \_\_\_\_\_  
(example: 23' 5")

Ceiling height \_\_\_\_\_  
(example: 8')

Siding \_\_\_\_\_  
(example: lap or T-111)

Wall sheathing \_\_\_\_\_  
(example: 1/2" exterior plywood)

2x \_\_\_\_\_ studs @ \_\_\_\_\_ O.C.  
(example: 2 x 6 @ 24" O.C.)

Cont. 2x \_\_\_\_\_ sill plate  
(example: 2 x 6)

Wall Insulation \_\_\_\_\_  
(If heated - example: R-20 Fiberglass Batts)

Foundation Insulation \_\_\_\_\_  
(If heated - example: R-10)

Footing size \_\_\_\_\_ x \_\_\_\_\_  
(example: 8" x 16")

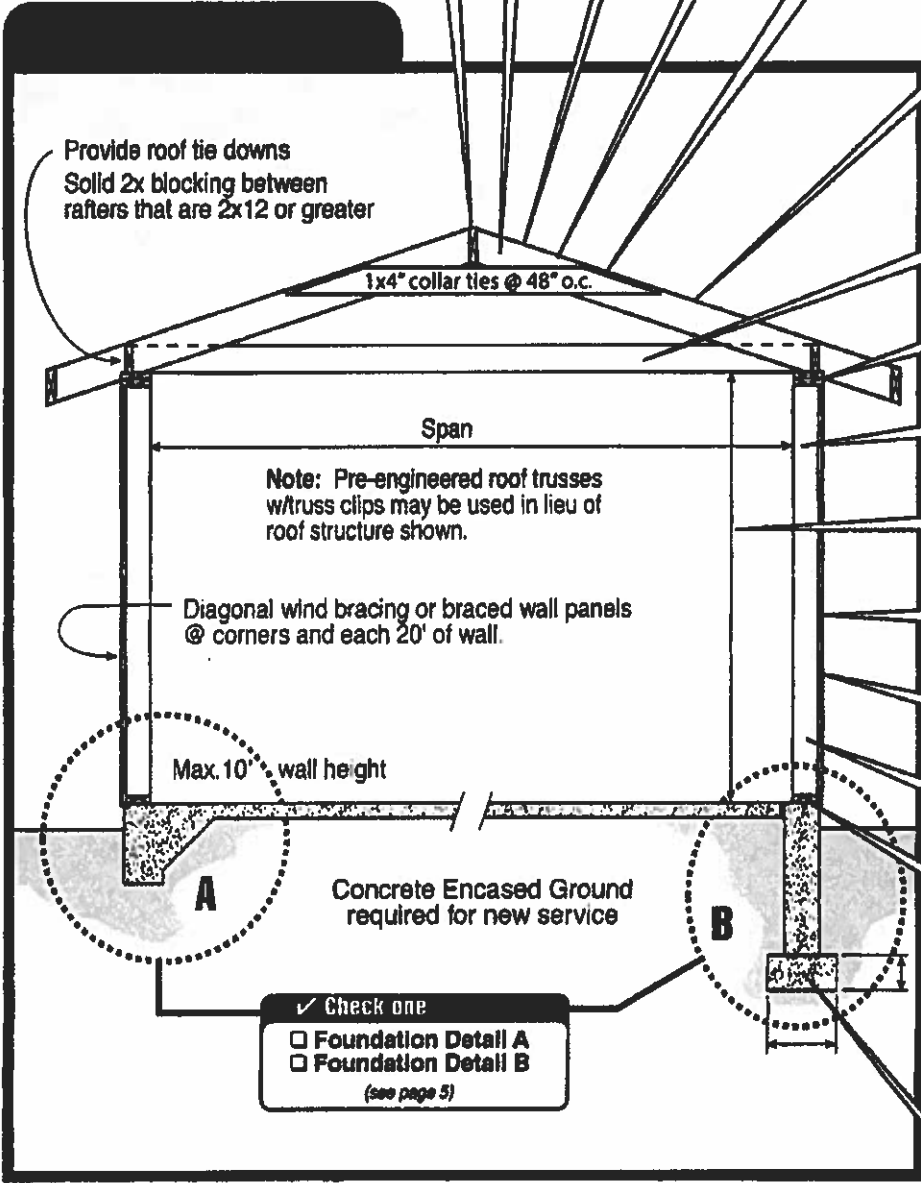

Check one  
 Foundation Detail A  
 Foundation Detail B  
(see page 5)

This handout was developed by the Colorado Chapter of the International Code Council as a basic plan submittal under the 2012 International Residential Code. It is not intended to cover all circumstances. Check with your Department of Building Safety for additional requirements.

# Single Family Residential One Story Detached Garage

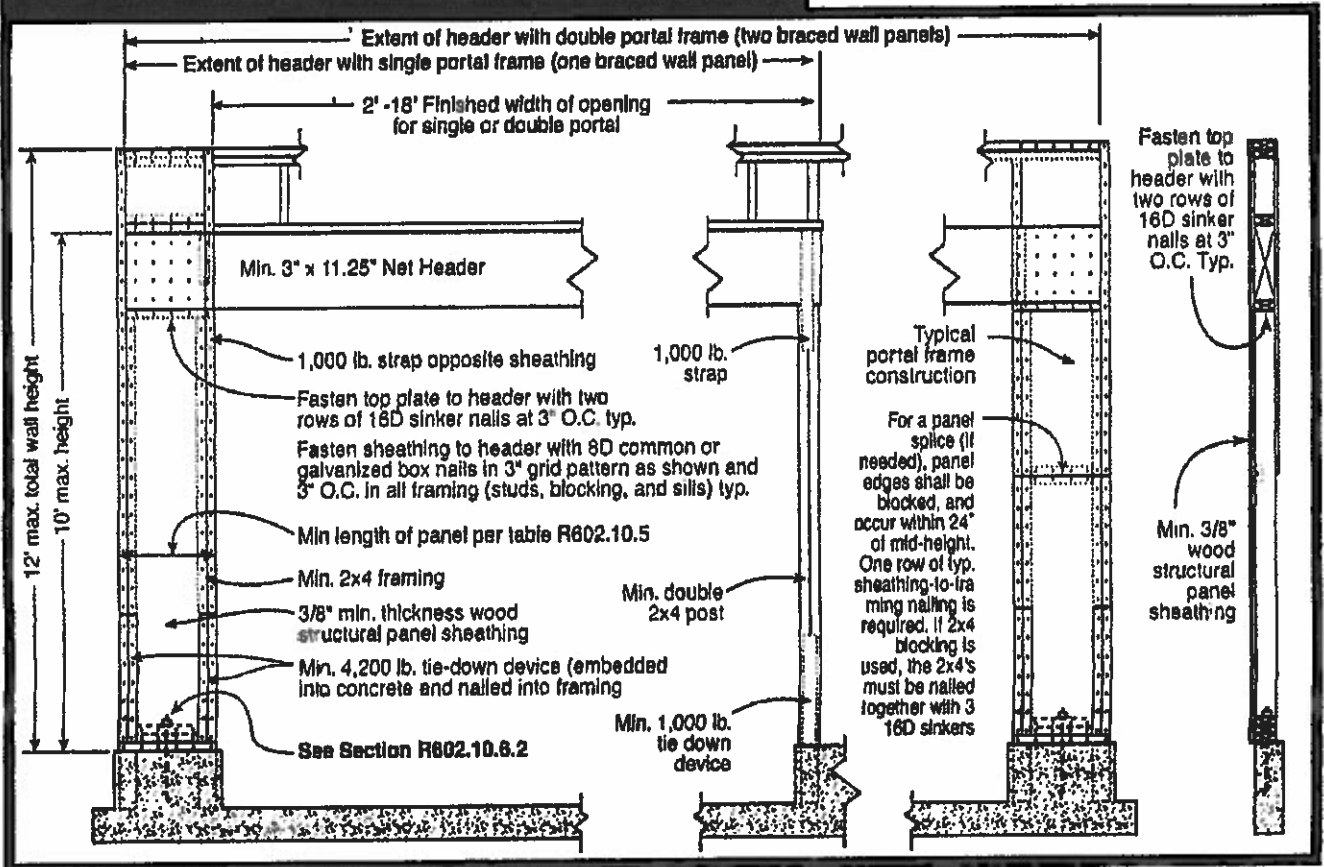
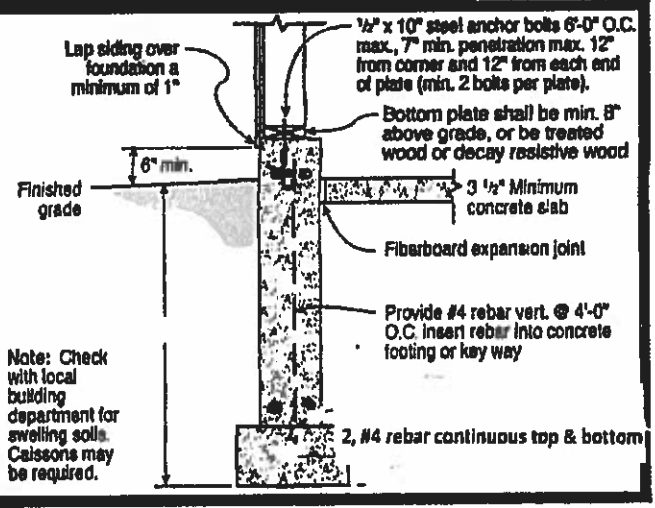
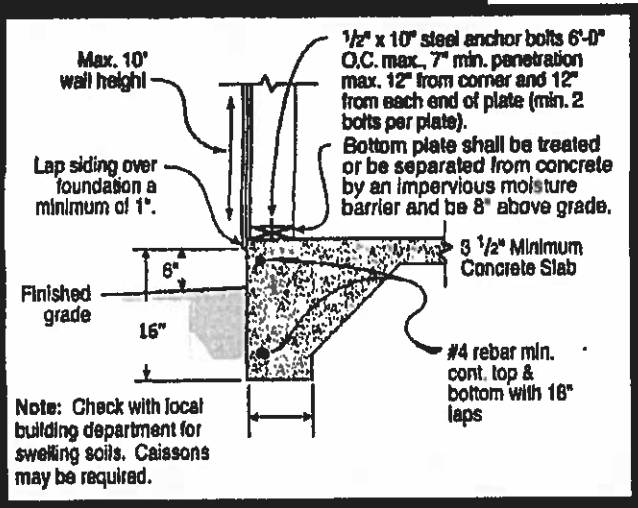

This handout was developed by the Colorado Chapter of the International Code Council as a basic plan submittal under the 2012 International Residential Code. It is not intended to cover all circumstances. Check with your Department of Building Safety for additional requirements.